

Geometry

Find the missing angle measure.

1

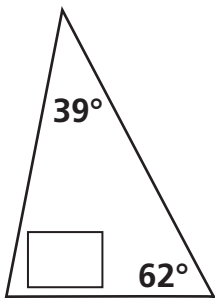

2

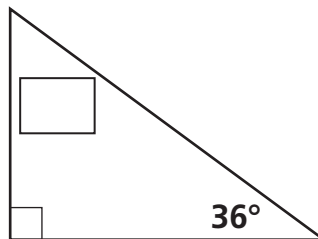

3

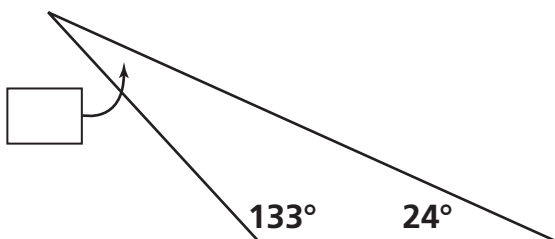

4

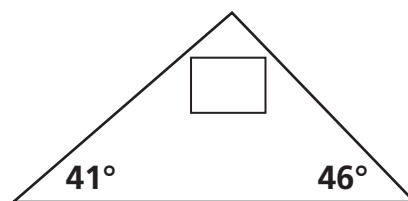

Problem Solving

Find the area of the figure. Use a strategy and solve.

5

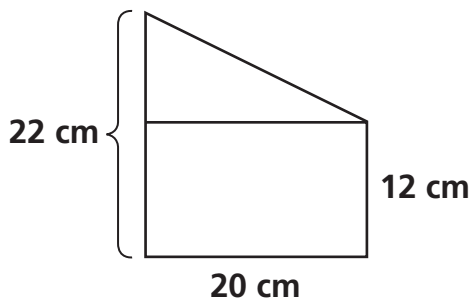

Area = _____

6

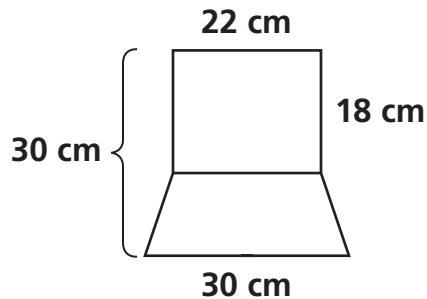

Area = _____

7

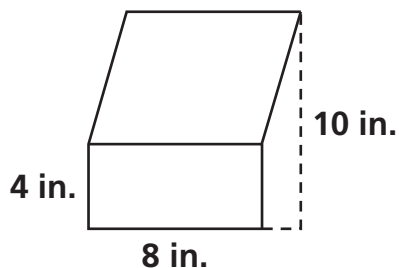

Area = _____

8

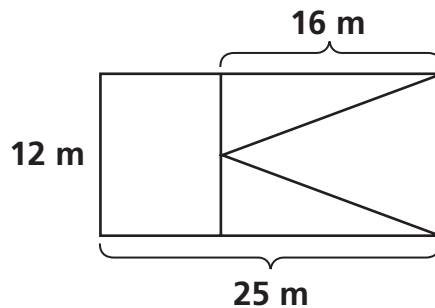

Area = _____